

!WARNING!
SPACE BETWEEN DOOR AND HOISTWAY
MUST NOT EXCEED 3"

INTERLOCKS CONFORMING TO ASME A17.1
MUST BE INSTALLED AND ADJUSTED PER
THE MANUFACTURER'S INSTRUCTIONS.

**!FAILURE TO COMPLY
MAY RESULT IN SERIOUS
INJURY OR DEATH!**

NOTE:
LEAVE ROUGH OPENING MIN
14" WIDER & 14" HIGHER THAN
CLEAR OPENING, AS SHOWN.

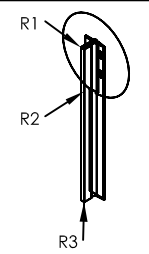
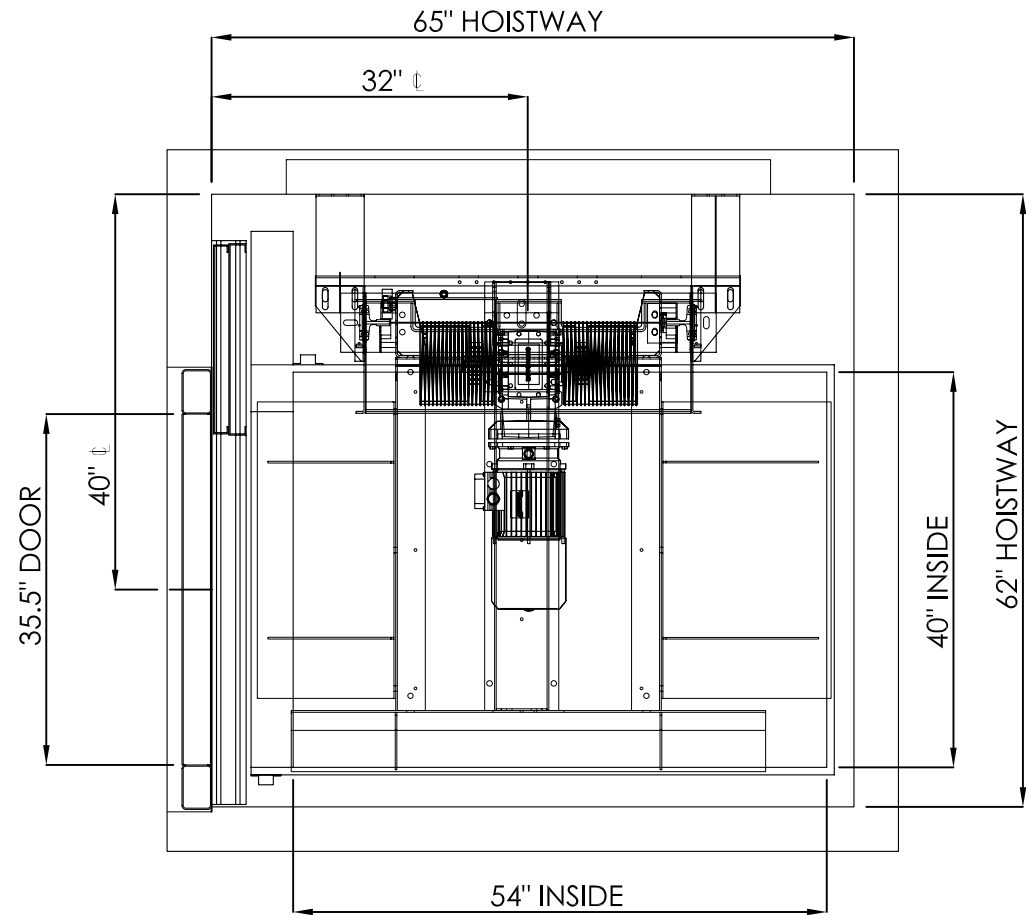
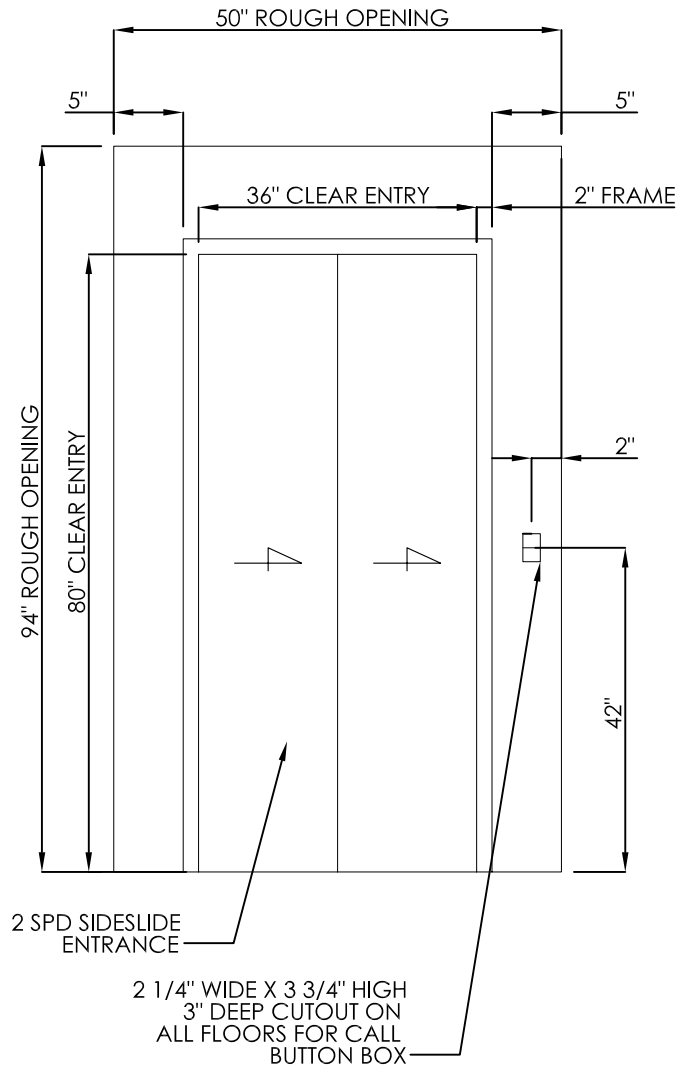

RAIL WEIGHT: 8 lbs/ft	
RAIL FORCES	
*R1 (Fx)	1075 lbs
*R2 (Fy)	358 lbs
R3 (Fz)	2500 lbs

SIZE	Nationwide Lifts www.elevators.com	
A	P: 888-695-4387	E: info@elevators.com
PART NO. 40 X 54, 1L		
SHEET 1 OF 3		
DESCRIPTION: SLIDING DOORS, OVERHEAD DRUM		

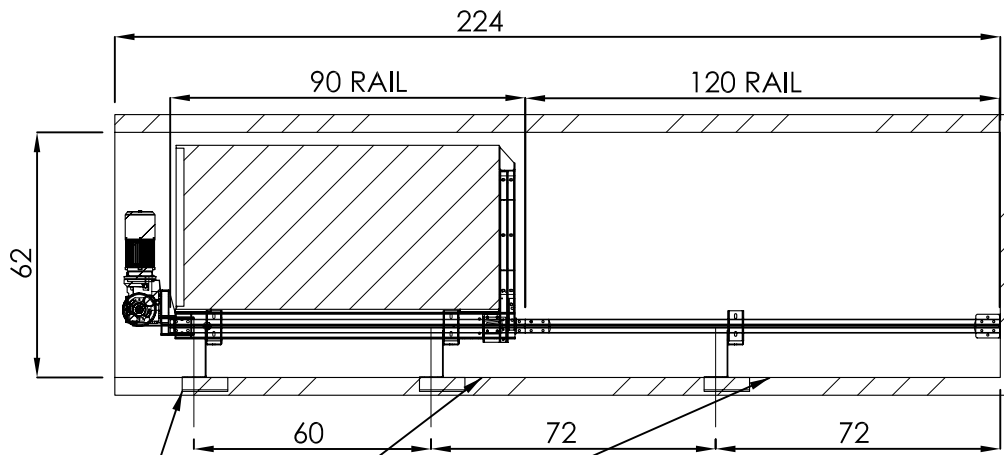

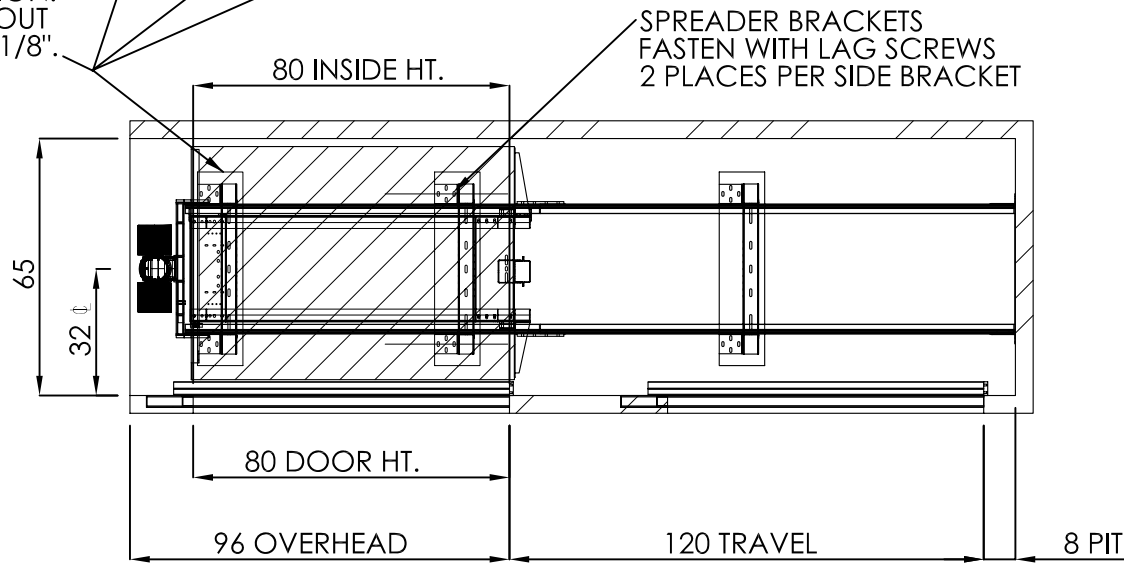

BRACKET LOCATIONS MAY VARY
ACORDING TO TRAVEL

PROVIDE WALL CONSTRUCTION
SUITABLE FOR ATTACHMENT OF
RAIL BRACKETS AT SHOWN ELEVATION.
MUST BE CAPABLE OF 300LB PULLOUT
LOADING WITH MAX DEFLECTION OF 1/8".

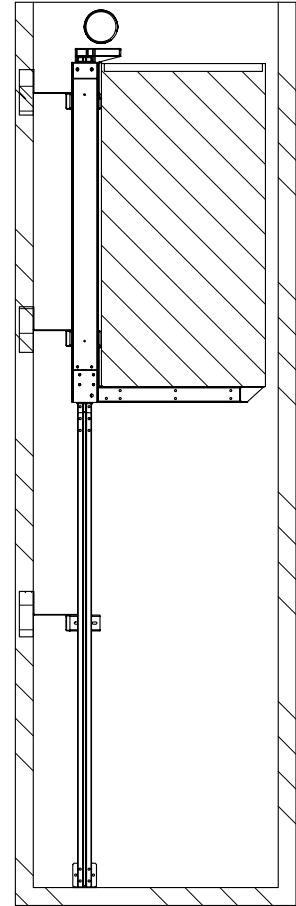
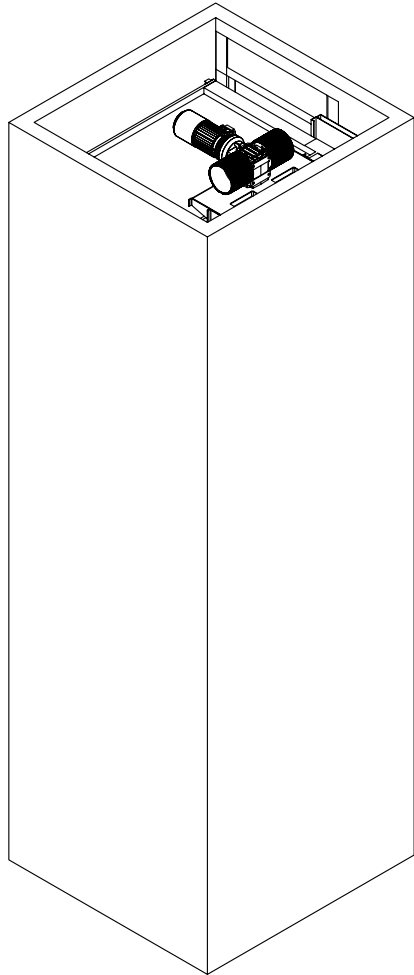
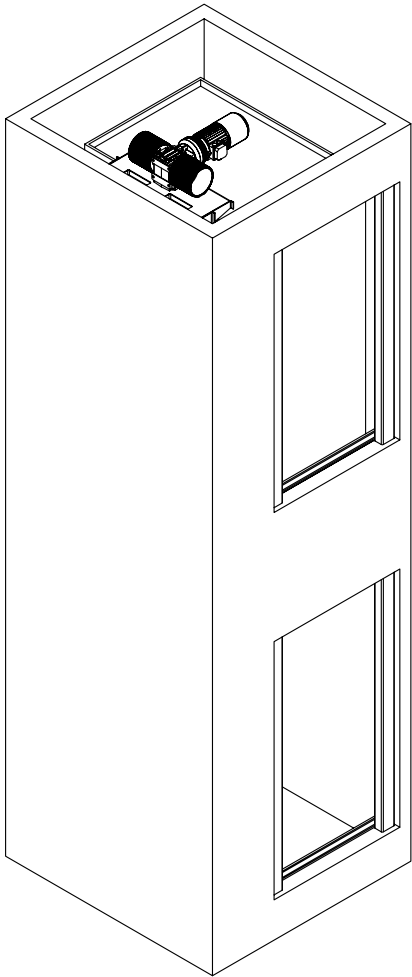

SIZE	 www.elevators.com P: 888-695-4387 E: info@elevators.com
A	
PART NO.	40 X 54, 1L
SHEET 2 OF 3	
DESCRIPTION:	SLIDING DOORS, OVERHEAD DRUM



SIZE	 Nationwide Lifts www.elevators.com P: 888-695-4387 E: info@elevators.com
A	
PART NO.	40 X 54, 1L SHEET 3 OF 3 DESCRIPTION: SLIDING DOORS, OVERHEAD DRUM

5



4

3

2

1