

PLEASE NOTE:  
 - OVERALL HOISTWAY LENGTH AND WIDTH DIMENSIONS ARE FROM DRYWALL TO DRYWALL (WHERE APPLICABLE)  
 - CAB WITH LIGHT SCREEN

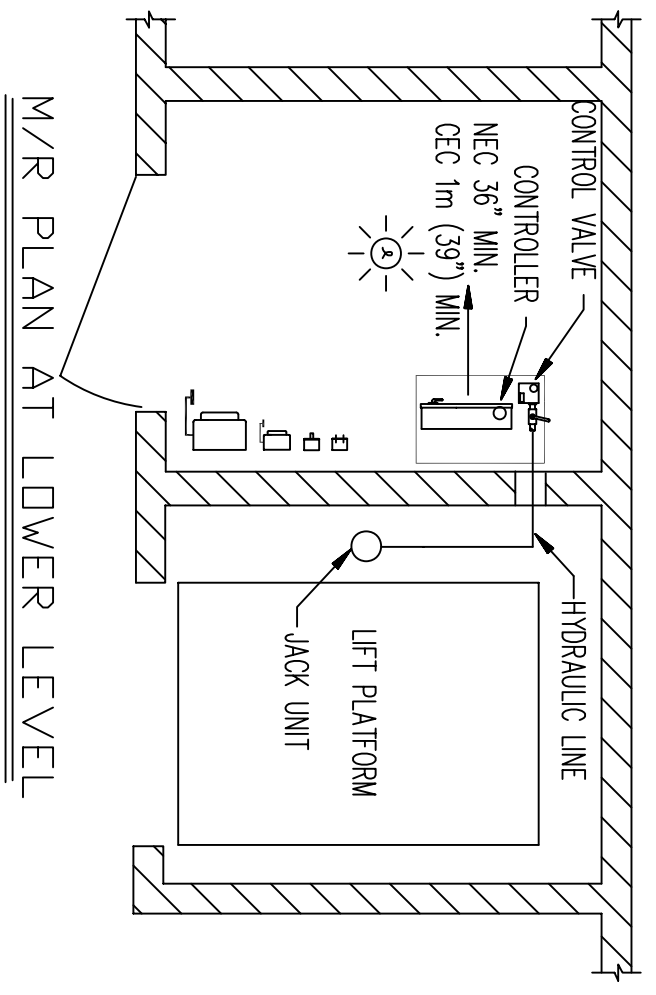
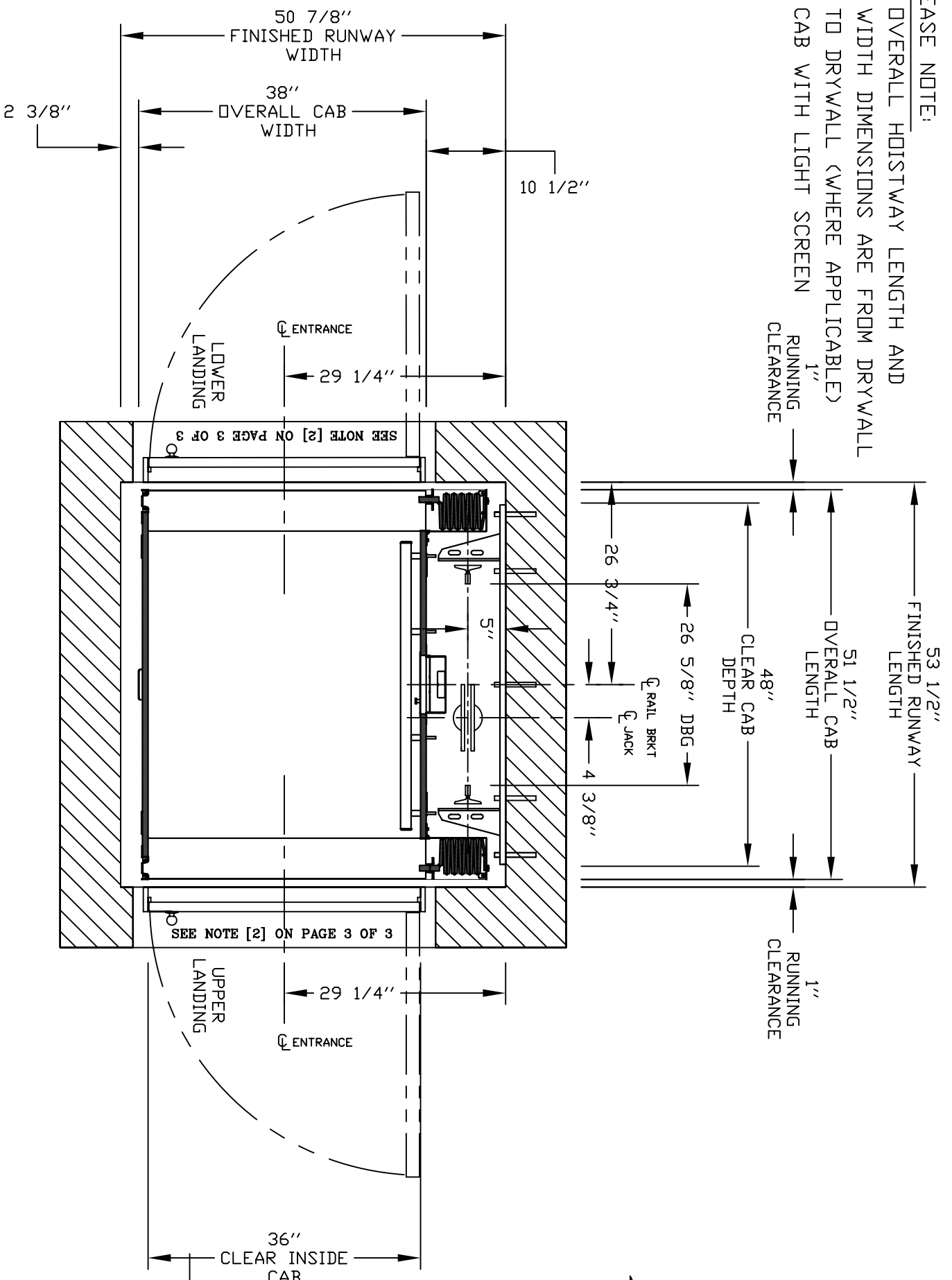

PRELIMINARY DRAWING ONLY  
 DRAWING APPROVAL:

THIS DRAWING REFLECTS OUR INTERPRETATION OF THE INFORMATION PROVIDED BY THE DEALER ON THE ORDER FORM. THIS INFORMATION IS THE DEALER'S RESPONSIBILITY, AND IS THE BASIS FROM WHICH THIS LIFT IS DESIGNED AND MANUFACTURED. PLEASE INDICATE THE REQUESTED ACTION BY CHECKING ONE OF THE FOLLOWING BOXES AND SIGNING BELOW TO AUTHORIZE COMPLETION OF THIS ORDER.

- APPROVED WITH NO EXCEPTIONS
- MANUFACTURE PRODUCT AS PER DRAWING
- APPROVED WITH EXCEPTIONS, NO REAPPROVAL REQUIRED
- MAKE CHANGES AS NOTED, NO REAPPROVAL DRAWING REQUIRED
- CHANGE AS NOTED, REAPPROVAL REQUIRED
- MAKE CHANGES AS NOTED, SEND CORRECTED DRAWING FOR REAPPROVAL BEFORE MANUFACTURE

SIGNATURE: \_\_\_\_\_ DATE: \_\_\_\_\_  
 CHANGES REQUEST:  
 1. \_\_\_\_\_  
 2. \_\_\_\_\_  
 3. \_\_\_\_\_  
 4. \_\_\_\_\_  
 CAUTION: ONCE THE DRAWING IS APPROVED, JOB CANCELLATION FEES WILL APPLY

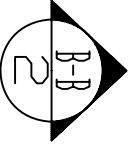

# PLAN VIEW

CUSTOMER: **TIOWIDE LIFTS**  
 PROJECT: Freedom Hydro - 36 wide x 48 deep  
 ADDRESS: Doors Opposite Sides, Rails on Left  
 888-323-8755 info@elevators.com

OFFICE USE ONLY:	Part No.
CONVERSION VERSION STAMP: 0.0	Variant No. 48546
MODEL VERSION STAMP: 15-633	DATE: 06/16/15
	REVISION DATE: 06/16/15
	COMPLETED BY: [Signature]

www.elevators.com  
  
 JOB No. P-00000011  
 SHEET No. 3

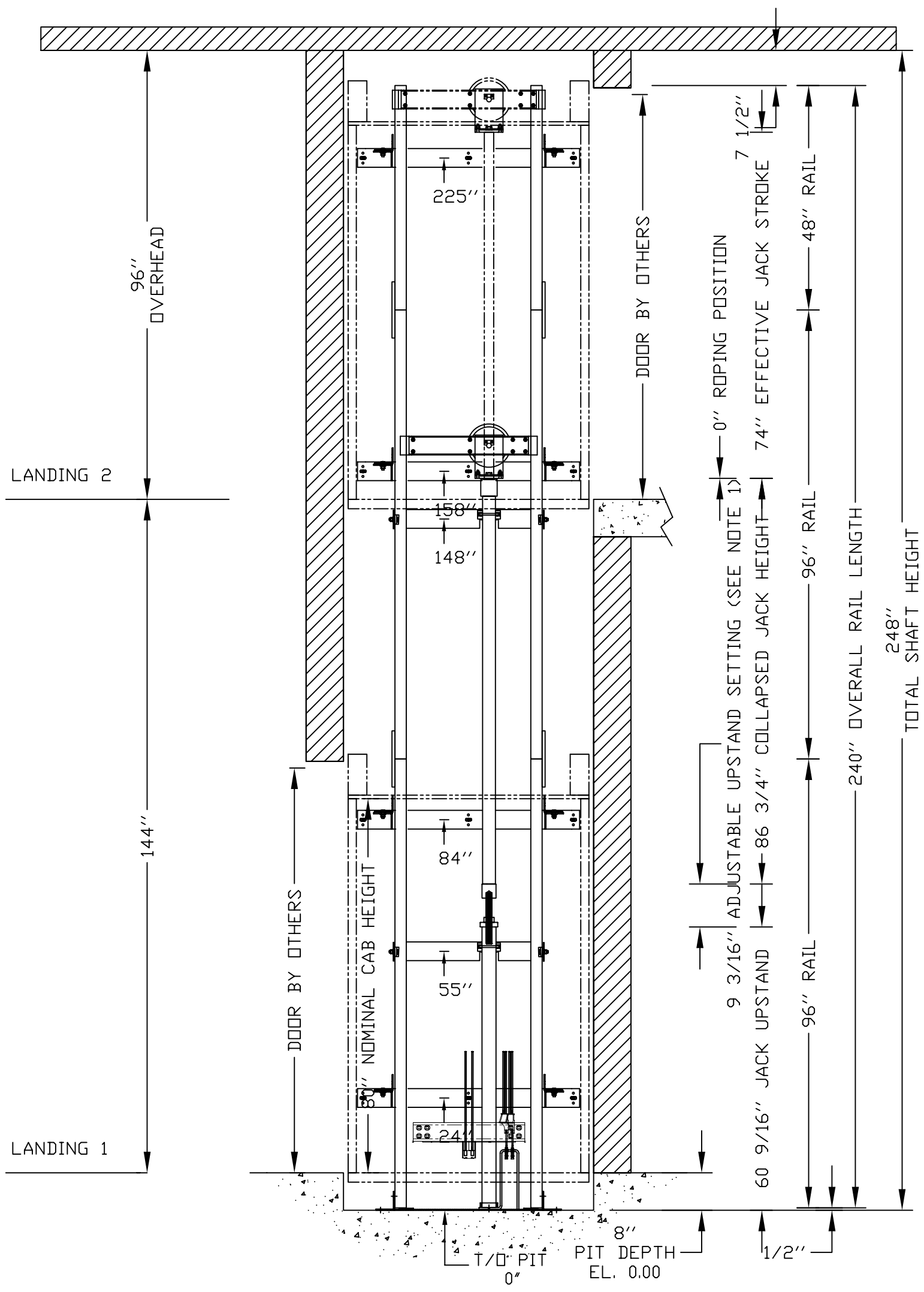



ELEVATION VIEW B-B

CUSTOMER: **NATIONWIDE LIFTS**  
 PROJECT: Freedom Hydro - 36 wide x 48 deep  
 ADDRESS: Doors Opposite Sides, Rails on Left  
 888-323-8755 info@elevators.com

OFFICE USE ONLY:  
 CONFIGURATION VERSION STAMP: 0.0  
 MODULE VERSION STAMP: I-S-6.33

DATE: 06/16/15  
 REVISION DATE: 06/16/15  
 COMPLETED BY: andy@nwlifts

Part No.	
Variant No.	48546
 <a href="http://www.elevators.com">www.elevators.com</a>	
	
JOB No.	P-000000
SHEET No.	2 OF 3

# PROVISIONS BY OTHERS

## \*GENERAL

**HOISTWAY**- THE HOISTWAY MUST BE IN ACCORDANCE WITH NATIONAL US/ASME (SEE APPLIED CODE), ALL STATE AND LOCAL CODES.

**PLUMB HOISTWAY**- DUE TO CLOSE RUNNING CLEARANCES OWNER/AGENT MUST ENSURE THAT HOISTWAY AND PIT (WHERE PROVIDED) ARE LEVEL, PLUMB AND SQUARE AND ARE IN ACCORDANCE WITH THE DIMENSIONS ON THESE DRAWINGS.

**MINIMUM OVERHEAD CLEARANCE**- OWNER/AGENT MUST ENSURE MINIMUM OVERHEAD CLEARANCE IS IN COMPLIANCE WITH CODES.

**CONSTRUCTION SITE**- OWNER/AGENT TO PROVIDE ALL MASONRY, CARPENTRY AND DRYWALL WORK AS REQUIRED AND SHALL PATCH AND MAKE GOOD (INCLUDING FINISH PAINTING) ALL AREAS WHERE WALLS/FLOORS MAY REQUIRE TO BE CUT, DRILLED OR ALTERED IN ANY WAY TO PERMIT THE PROPER INSTALLATION OF THE LIFT. DIMENSIONS.

**CONTRACTOR/CUSTOMER** TO VERIFY ALL DIMENSIONS AND REPORT ANY DISCREPANCIES TO OUR OFFICE IMMEDIATELY.

## \*STRUCTURAL

**FLOOR/SUPPORT WALL LOADS**- CONTRACTOR TO ASSURE THAT BUILDING AND SHAFT WILL SAFELY SUPPORT ALL LOADS IMPOSED BY THE LIFT EQUIPMENT. REFER TO THE TABLES ON THIS DRAWING FOR LOADS IMPOSED BY THE EQUIPMENT.

**DOORS**- SUITABLE LINTELS MUST BE PROVIDED BY OWNER/AGENT. DOOR FRAMES ARE NOT DESIGNED TO SUPPORT OVERHEAD WALL LOADS. ALL FULL HEIGHT DOORS MUST BE ALIGNED WITH THE DOOR CENTER LINE. DOOR WITH THE CORE IS BETTER THAN THE HOLLOW DOOR.

**NOTICE(2)**- CLEARANCES FROM DOOR SILL TO HOISTWAY DOOR TO BE 3" (76mm) MAXIMUM AND ELEVATOR CAR DOOR TO HOISTWAY DOOR TO BE 5" (127mm) MAXIMUM TO COMPLY WITH CSA B44 (ASME/ANSI A17.1). CONSULT YOUR LOCAL INSPECTION AUTHORITIES FOR CODES WHICH MAY TAKE PRECEDENCE. N/A WITH SLIM AND FLUSH DOORS.

**ENTRANCE ASSEMBLIES**- ENTRANCE ASSEMBLIES MUST BE ADJUSTED TO ALIGN WITH PLATFORM AND INTERLOCK EQUIPMENT. OTHERS TO ALLOW AN ADEQUATE ROUGH OPENING.

**RETURN WALLS**- RETURN WALLS AT ENTRANCES MUST BE BUILT-IN BY OTHERS AFTER ENTRANCE ASSEMBLIES ARE IN PLACE. ENTRANCE ASSEMBLY MUST BE SECURELY FASTENED TO WALLS BY ELEVATOR CONTRACTOR.

## \*MACHINE ROOM

**LOCATION / ACCESS**- MACHINE ROOM LOCATED AT THE LOWEST LEVEL ADJACENT TO HOISTWAY, UNLESS SHOWN OTHERWISE ON THE LAYOUT DRAWINGS. FIELD ADJUSTMENT BY INSTALLER MAY BE NECESSARY TO MEET JOB SITE CONDITIONS OR REGULATIONS. MACHINE ROOM DOOR IS TO BE LOCKABLE AND IS TO MEET THE REQUIREMENTS OF THE AUTHORITY HAVING JURISDICTION. SLEEVES FOR OIL & ELECTRIC LINES- FROM MACHINE ROOM TO RUNWAY AS REQUIRED. (POSITION PER INSTALLERS INSTRUCTIONS).

DISCONNECT SIZE	TIME DELAY	FUSE SIZE	VOLTS	PHASE	AMPERAGE
MOTOR & EQUIP	30 AMPS	30 AMPS	230 volt	Single Phase	159 AMPS
CAB LIGHTS	15 AMPS	15 AMPS	115 V	1	

## \*ELECTRICAL

**POWER SUPPLY**- (SEE SPECIFICATIONS) LOCKABLE FUSED DISCONNECT WITH AUXILIARY CONTACT TO BRAKE THE BATTERY FEED, OR CIRCUIT BREAKERS WITH A 3-POLE BREAKER FOR BATTERY FEED REQUIRED, IN COMPLIANCE WITH ELECTRICAL CODE, AS FOLLOWS:

LOCATED ON WALL ON LOCK JAMB SIDE OF MACHINE ROOM DOOR) PERMANENT POWER- BEFORE INSTALLATION CAN BEGIN. PERMANENT

**LIGHTING**- THE ILLUMINATION SHALL BE NOT LESS THAN 200 LX (19 FC) AT THE FLOOR LEVEL IN ALL MACHINE ROOMS AND MACHINERY SPACES. ENSURE AT LEAST 100 LX (10 FC) AMBIENT LIGHTING OVER LIFT AREA.

**PHONE**- NEED A PHONE LAND LINE (NOT VOIP) FOR THE PHONE. WHERE APPLICABLE. FOR VOIP PLEASE CONTACT SAVARIA.

## \*ENTRANCES

**FASCIA PANEL** BELOW UPPER LEVEL ENTRANCE- WHERE REQUIRED, FASCIA PANEL MUST BE FASTENED TO A SOLID WALL AND BE PERPENDICULAR TO THE FLOOR AND WALLS. HOISTWAY FASCIA IS NOT SELF-SUPPORTING FOR LONG, CONTINUOUS RUNS VOID OF ENTRANCES. ADEQUATE SUPPORT FOR THE FASCIA MUST BE PROVIDED.

## GENERAL

**CLASSIFICATION**: Residential Building  
**APPLIED CODE**: ASME 17.1-2010 SEC. 5.3  
**MODEL**: Infinity  
**CAPACITY**: 1000lbs  
**NOMINAL SPEED**: 36 fpm UP AND DOWN  
**TRAVEL**: 144" [3.66 m]  
**PIT DEPTH**: 8"  
**POWER SUPPLY**: 60 Hz Single Phase 230 volt

## HYDRAULIC

**PUMP MFR.**: CONCORD  
**PUMP MODEL**: VICKERS 2P  
**MOTOR**: 3.0 hp FROM NIDEC  
**VALVE MODEL NO.**: EPV - 4  
**VALVE COIL VOLTS**: 24 V DC  
**MAX WORKING PRESSURE**: 1600 psi (11032 kPa)  
**RELIEF VALVE SETTING**: MAX 25% ABOVE ACTUAL WORKING PRESSURE  
**RESERVOIR**: 22 Gal.

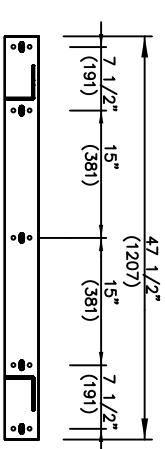
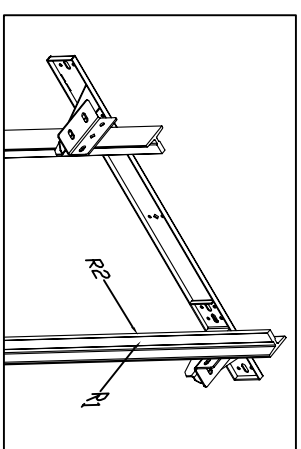

## FIRST DOOR BY LANDING CHART

DOOR TYPE	LANDING 1	LANDING 2
ENTRANCE SIDE	Doors By Others	Doors By Others
DOOR SWING	Side A	Side C
LOCK TYPE	Right Hand	Left Hand
AUTO DOOR OPENER	Honeywell	Honeywell
HALL CALL KEY SWITCH	1	2

## RAIL BRACKET

RAIL FORCES	R3 NOTE:
	PIT FLOOR TO SUPPORT LOAD OF: 6.4 kips *(INCLUDES IMPACT)
*R1	
*R2	
304 lbf	
194 lbf	
RAIL WEIGHT : 80 lbs / ft	

FOR TOTAL PULL-OUT FORCE ON RAIL BRACKET, R1 MUST BE DOUBLED eg. 2 x 304 = 608 lbf

# SPECIFICATIONS

## CAR FINISH DETAILS

**CAB PANEL SELECTION**: To Be Determine  
**HARDWOOD FINISHES**: Not applicable  
**CEILING SELECTION**: standard (white)  
**BRASS CAB PKG REQ'D?**: LED Pot Light  
**POT LIGHT FINISH**: Stainless Steel  
**TRIM COLOUR**: Clear Anodized Aluminum  
**CAR STATION PLATE**: Clear Anodized Aluminum  
**HAND RAIL TYPE**: Clear Anodized Aluminum  
**CAB FLOORING**: Plywood Floor 3/4"  
**FINISHED FLOOR THICKNESS**: 3/4" finish  
**TELEPHONE CABINET**: no

## CAR DIMENSIONS/PLATFORM GATES

**CAB TYPE**: Type 2  
**CAB OPERATION**: auto  
**GATES REQUIRED**: Manual Gate(s)  
**GATE TYPE**: Panel Fold/Clear/WhT 3 Plexi  
**GATE FINISH**: Gate Finish : Standard Hinges w Light Screen  
**LANDING DOOR FINISH**: N/A

## JACK UNIT

**EFFECTIVE STROKE**: 74"  
**PLUNGER O/D**: 2"  
**CYLINDER O/D**: 2 3/4"  
**CYLINDER I/D**: 2 1/4"  
**SPLIT CYLINDER?**: no  
**COLLAPSED LENGTH**: 86 3/4"

## SUSPENSION

**TYPE**: AIRCRAFT CABLE 2 X 3/8" DIA. RATIO 1:2  
**CONSTRUCTION**: 1WRC 7 X 19  
**NOMINAL STRENGTH**: 14,400 lbs Per Cable  
**SPECS**: MIL-83420  
**SAFETIES**: TYPE A

## OPTIONS

**PHONE**: Standard Phone Provided  
**TRAVELING CABLE**: Flat Traveling Cable  
**LED POT LIGHT**: LED Pot Light

## ENTRANCE SIDE LEGEND

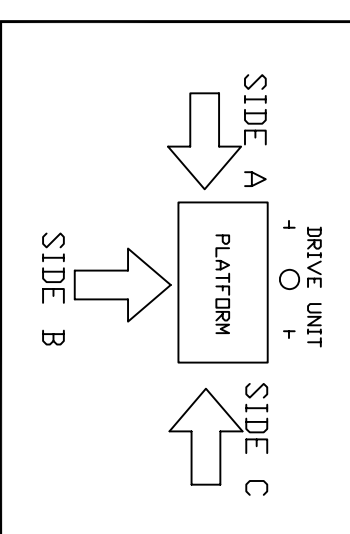

OFFICE USE ONLY:	DATE:
CONFIGURATION VERSION STAMP: 0.0	06/16/15
MODULE VERSION STAMP: 1-5-633	06/16/15

Port No. **48546**  
 Variant No. **48546**  
 www.elevators.com

# DATA SHEET

**CUSTOMER:** NATIONWIDE LIFTS  
**PROJECT:** Freedom Hydro - 36 wide x 48 deep  
**ADDRESS:** Doors Opposite Sides, Rails on Left  
 888-323-8755 info@elevators.com

**DATE:** 06/16/15  
**COMPLETED BY:** [Signature]  
**JOB NO.:** P-0000003  
**SHEET NO.:** 3

**Nationwide Lifts**  
 www.elevators.com  
**savaria**